

NOTE: FOR MORE DETAILS SEE YOUR V.P.CUSTOMER SERVICE REP.

REVISIONS			
REV.	DESCRIPTION	DATE	APPROVED
A	INITIAL RELEASE	10-01-97	
B	CO 046 Drafting Update	09-27-07	Rick C.
C	Changed Post Specification	12-10-07	Rick C.

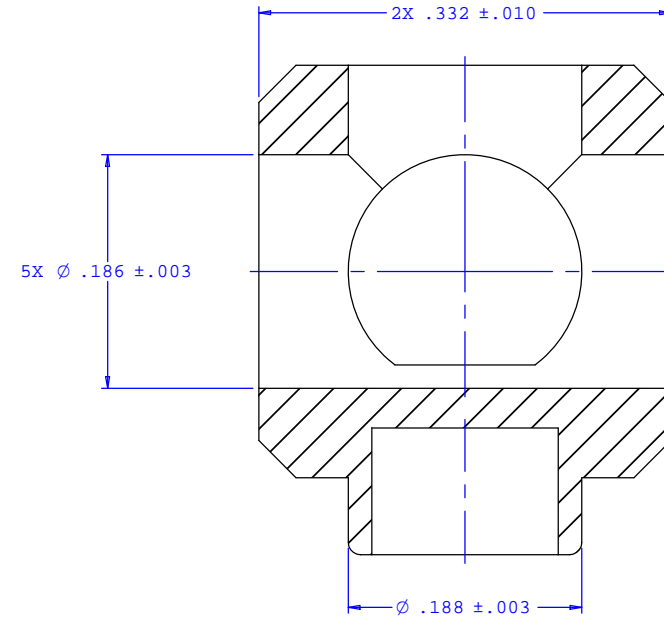

SECTION A-A

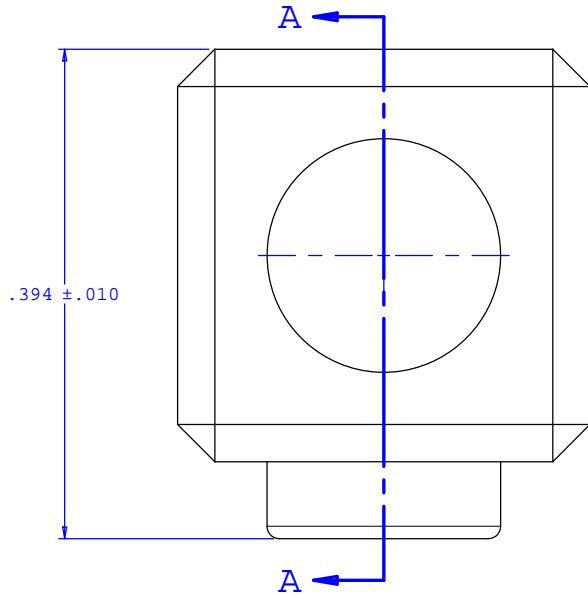
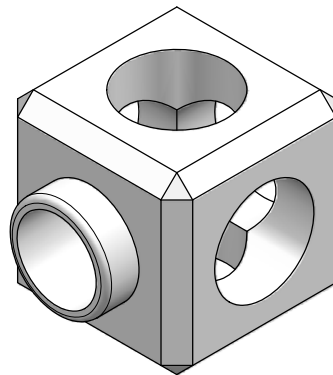

UNLESS OTHERWISE SPECIFIED DIMENSIONS ARE IN INCHES TOLERANCES ARE:		<b>VALUE PLASTICS, INC.</b>	
FRACTIONS ±	DECIMALS .XX ±.01 .XXX ±.005 .XXXX ±.001	ANGULAR ±1°	PART NUMBER: <b>BDJ19</b>
DO NOT SCALE DRAWING		DESCRIPTION: <b>Bondable Junction Block with Mounting Port</b>	
DRAWN BY: <b>Frank Lombardi</b>	DATE: <b>05-04-06</b>	SIZE: <b>B</b>	SCALE: <b>NTS</b>
ENGINEER/ MANAGER: <b>Rick Cairns</b>		DRAWING NUMBER: <b>1008751</b>	REV. <b>C</b>
© 2006 VALUE PLASTICS, INC.			SHEET: 1 OF 1

**FOR REFERENCE ONLY**